

### Superfast Recovery Rectifiers

Parameter	Value	Unit
$V_{RRM}$	100~600	V
$I_{F(AV)}$	5	A

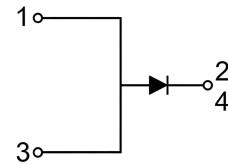

### Features

- High current capability
- Low forward voltage drop
- Low power loss, high efficiency
- High surge capability
- High temperature soldering guaranteed

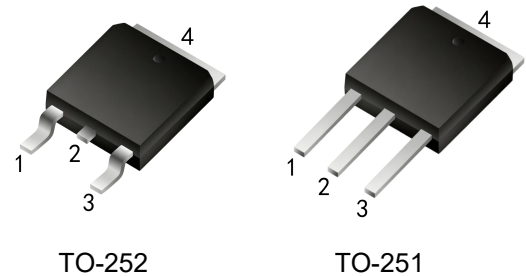

### Applications

- Typical applications are in switching power supplies, converters, freewheeling diodes, and reverse battery protection.

### Absolute Maximum Ratings (Ta=25°C, unless otherwise noted)

Parameter	TO-251	SF501VS	SF502VS	SF503VS	SF504VS	SF505VS	SF506VS	Unit
	TO-252	SF501DS	SF502DS	SF503DS	SF504DS	SF505DS	SF506DS	
Maximum Recurrent Peak Reverse Voltage	$V_{RRM}$	100	200	300	400	500	600	V
Maximum RMS Voltage	$V_{RMS}$	70	140	210	280	350	420	V
Maximum DC Blocking Voltage	$V_{DC}$	100	200	300	400	500	600	V
Maximum Average Forward Rectified Current	$I_{F(AV)}$	5.0						A
Peak Forward Surge Current 8.3ms Single Half Sine-Wave Super Imposed on Rated Load (JEDEC Method)	$I_{FSM}$	150						A
Maximum Forward Voltage at 5.0A DC	$V_F$	1.0		1.25		1.65		V
Maximum DC Reverse Current $T_J=25^\circ\text{C}$ at Rated DC Blocking Voltage $T_J=125^\circ\text{C}$	$I_R$			1.0		300		$\mu\text{A}$
Typical Junction Capacitance Per Element (Note1)	$C_J$	45						pF
Typical Thermal Resistance(Note2)	$R_{\theta JC}$	15						$^\circ\text{C}/\text{W}$
Maximum Reverse Recovery Time(Note3)	$T_{rr}$	35						ns
Operating Temperature Range	$T_J$	-55 to +150						$^\circ\text{C}$
Storage Temperature Range	$T_{STG}$	-55 to +150						$^\circ\text{C}$

#### Notes:

1. Measured at 1.0MHz and applied reverse voltage of 4.0V DC.
2. Mounted on 10cm x 10cm x 1mm copper pad area
3. Reverse Recovery Test Conditions:  $I_F=0.5\text{A}$ ,  $I_R=1\text{A}$ ,  $I_{rr}=0.25\text{A}$

## Typical Characteristics

FIG.1 - FORWARD CURRENT DERATING CURVE

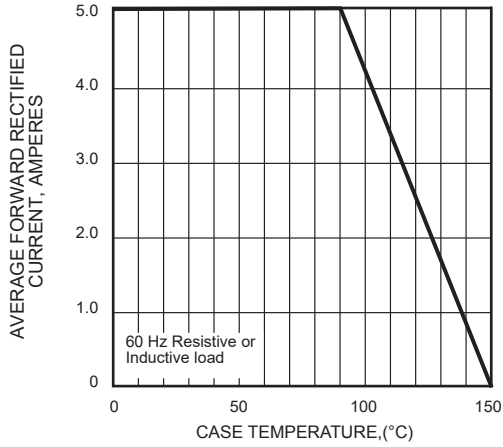

FIG.2 - MAXIMUM NON-REPETITIVE PEAK FORWARD SURGE CURRENT

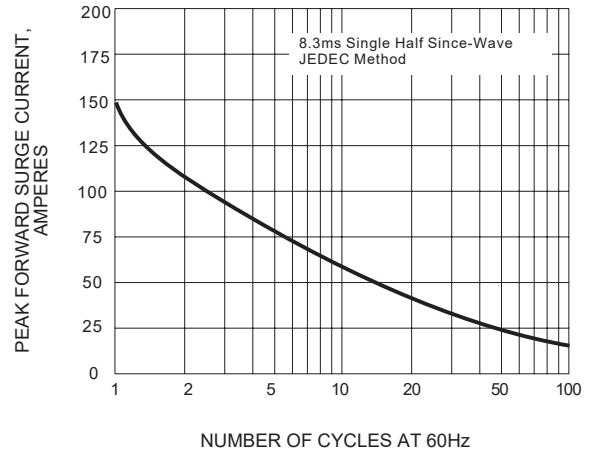

FIG.3 - TYPICAL INSTANTANEOUS FORWARD CHARACTERISTICS

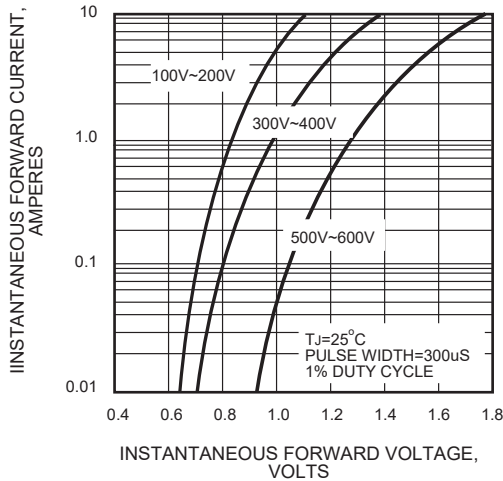

FIG.4 - TYPICAL REVERSE CHARACTERISTICS

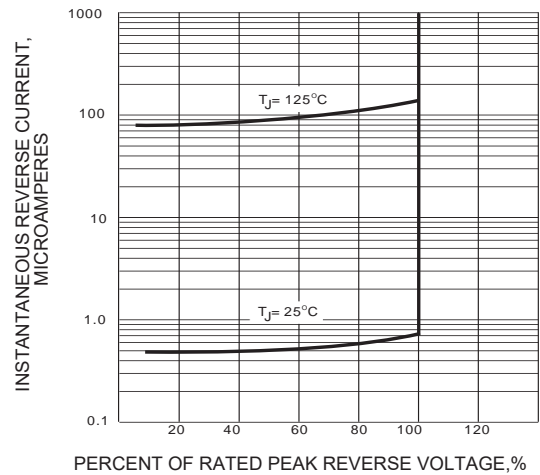
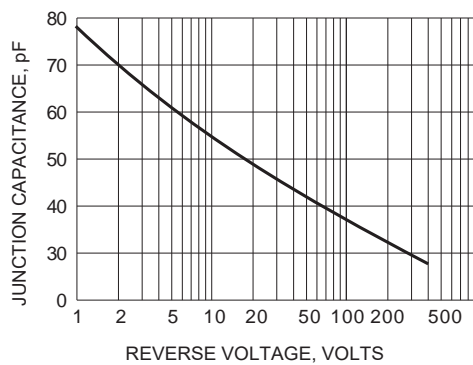
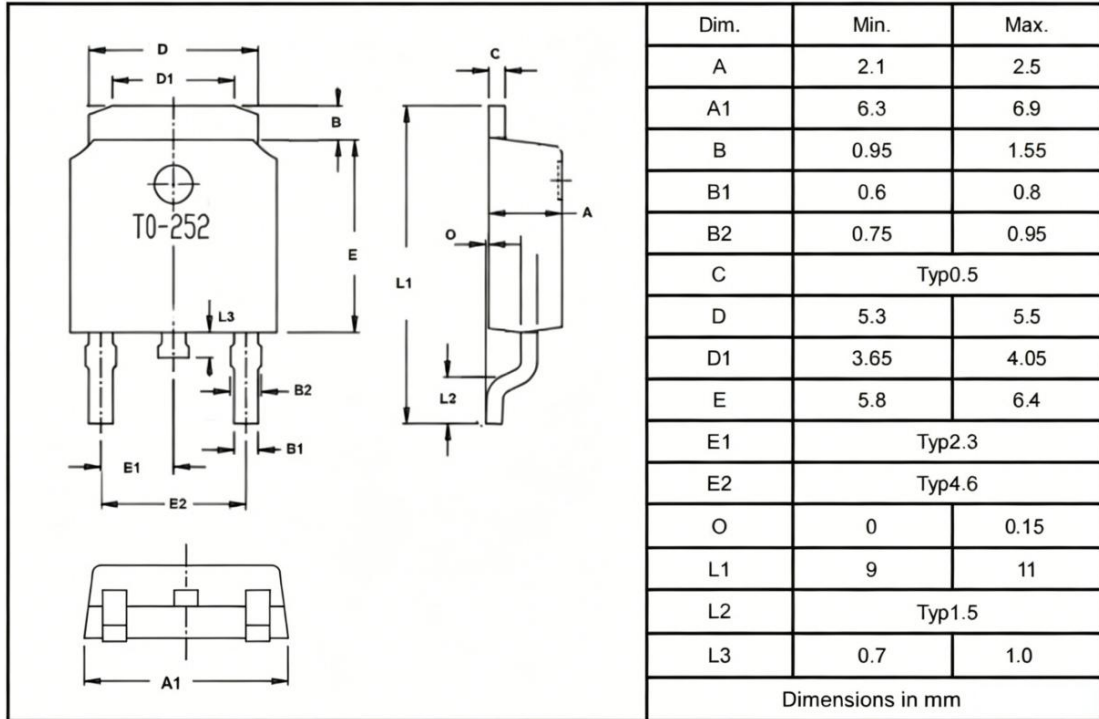

FIG.5 - TYPICAL JUNCTION CAPACITANCE



### Package Outlines

#### TO-252



#### TO-251

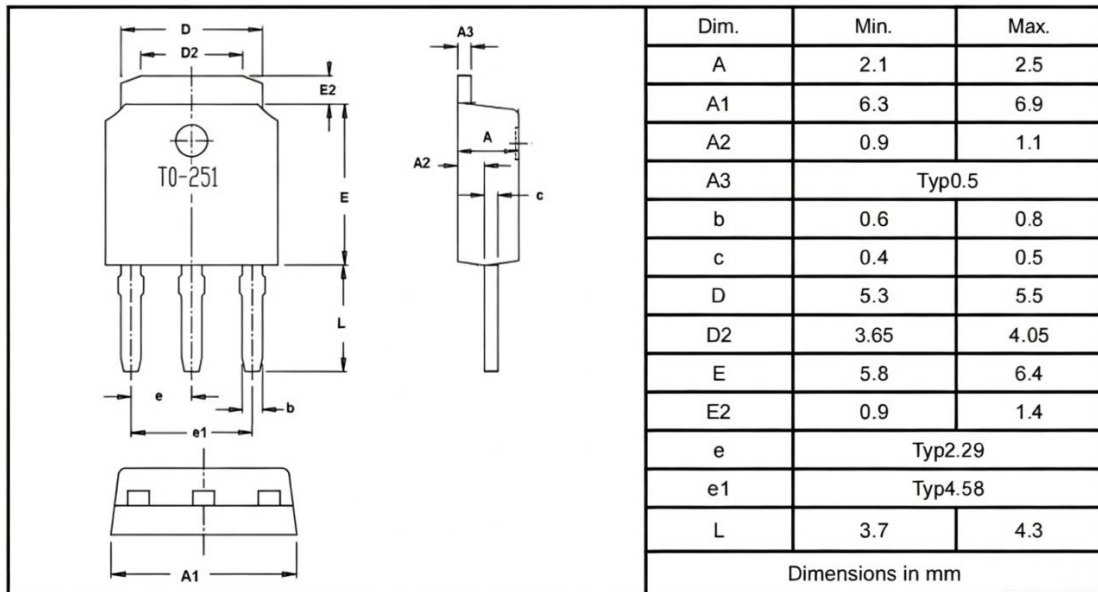

**\*Important Usage Information and Disclaimer**

The specifications of Zhuhai Hypersemi Co., Ltd. products are not guarantees of product characteristics. They reflect typical performance expected in standard applications, which may vary with specific uses. Users must conduct prior testing for their applications and make necessary adjustments.

Users are responsible for the safety of applications utilizing our products and must implement adequate safety measures to prevent physical injury, fire, or other risks in case of product failure. It is the user's duty to ensure that application designs comply with all applicable laws and standards. Our products must not be used in any applications where a product failure could reasonably result in personal injury, unless specifically authorized in a signed document by Zhuhai Hypersemi Co., Ltd.

No representations or warranties are made regarding the accuracy or completeness of this information, including any claims of non-infringement of third-party intellectual property rights. Zhuhai Hypersemi Co., Ltd. assumes no liability for any applications or uses of its products and does not grant any licenses to its intellectual property rights or those of others. We also make no claims regarding non-infringement of third-party intellectual property rights that may arise from applications.

Due to technical requirements, our products may contain hazardous substances. For details, please contact your nearest sales office. This document replaces all previous information and may be updated. We reserve the right to make changes.