

Ultrafast Recovery Rectifiers

Parameter	Value	Unit
V_{RRM}	600	V
$I_{F(AV)}$	20	A

Features

- Low forward voltage drop
- High current capability
- High reliability
- High surge current capability

Applications

- Typical applications are in switching power supplies, converters, freewheeling diodes, and reverse battery protection.

Absolute Maximum Ratings ($T_a=25^\circ\text{C}$, unless otherwise noted)

Parameter	Symbol	MU2060	MUR2060F	MUR2060W	MUR2060DC	Unit
Maximum Repetitive reverse voltage	V_{RRM}	600				V
Maximum RMS voltage	V_{RMS}	420				V
Maximum DC blocking voltage	V_{DC}	600				V
Maximum average forward current	I_{AV}	20				A
Peak forward surge current, 8.3ms single half sine-wave superimposed on rated load	I_{FSM}	200				A
Typical thermal resistance per diode (Note 1)	$R_{\theta JC}$	2.0	4.5	2.5	2.5	$^\circ\text{C}/\text{W}$
Operating junction temperature range	T_J	-55 to +150				$^\circ\text{C}$
Storage temperature range	T_{STG}	-55 to +150				$^\circ\text{C}$

Notes: 1. Thermal resistance from junction to case.

Electrical Characteristics unless otherwise specified

Parameter	Symbol	Test Conditions	Min.	Typ.	Max.	Unit
Instantaneous forward voltage	V_F	$I_F=20\text{A}$ $T_J=25^\circ\text{C}$	-	1.8	2.1	V
		$I_F=20\text{A}$ $T_J=125^\circ\text{C}$	-	-	1.7	V
Reverse current per diode	I_R	$V_R=600\text{V}$ $T_J=25^\circ\text{C}$ $T_J=125^\circ\text{C}$	-	-	5500	μA
Reverse recovery time	T_{RR}	$I_F=0.5\text{A}$ $I_R=1.0\text{A}$ $T_J=25^\circ\text{C}$ $I_{RR}=0.25\text{A}$	-	34	48	ns
		$I_F=1\text{A}$ $V_R=30\text{V}$ $di/dt=200\text{A}/\mu\text{s}$ $T_J=25^\circ\text{C}$	-	32	-	

Typical Characteristics

FIG. 1 - TYPICAL FORWARD CURRENT DERATING CURVE

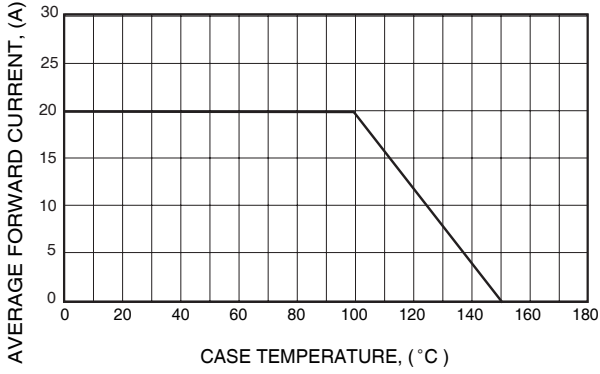

FIG. 2 - MAXIMUM NON-REPETITIVE FORWARD SURGE CURRENT

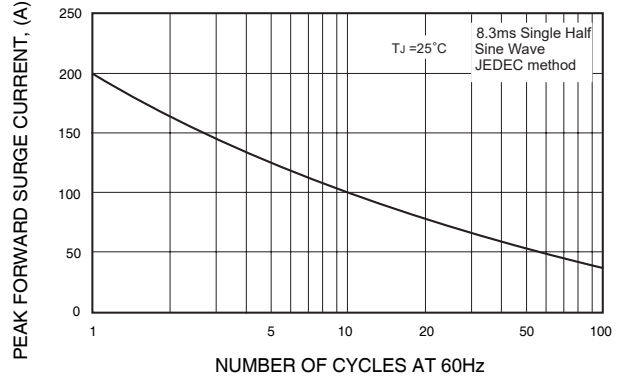

FIG. 3 - TYPICAL REVERSE CHARACTERISTICS

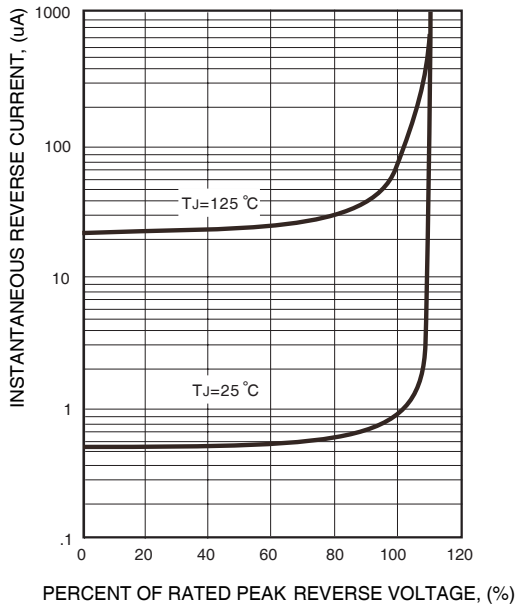
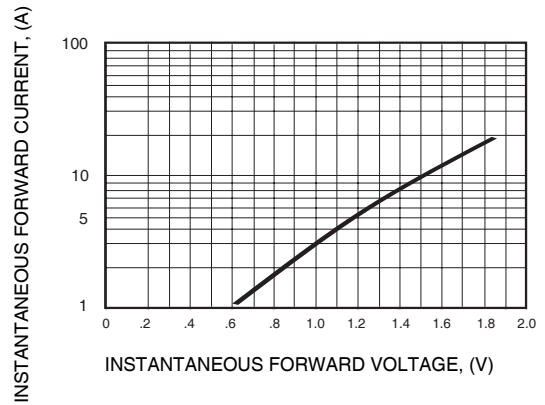
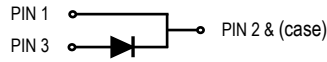

FIG. 4 - TYPICAL INSTANTANEOUS FORWARD CHARACTERISTICS



Package Outlines



Dimensions in millimeters

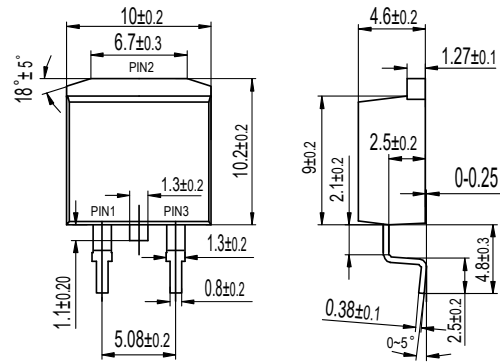
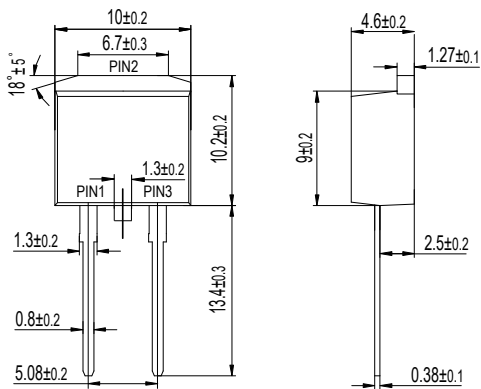
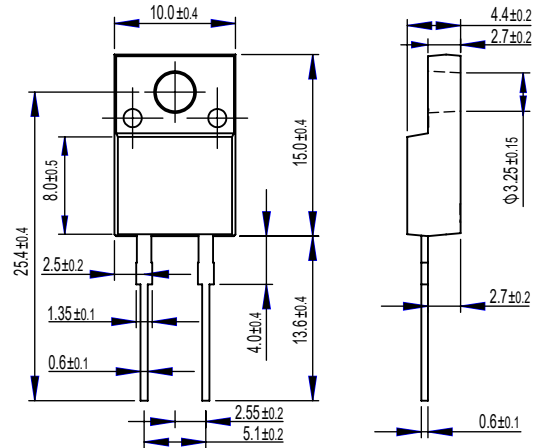
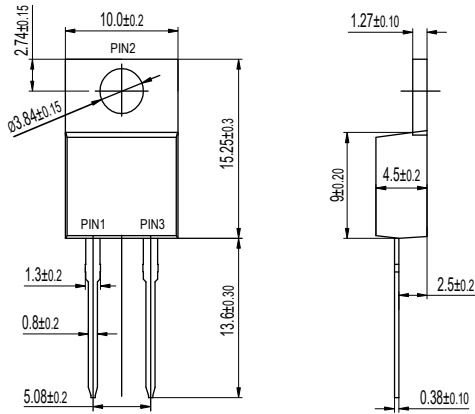

***Important Usage Information and Disclaimer**

The specifications of Zhuhai Hypersemi Co., Ltd. products are not guarantees of product characteristics. They reflect typical performance expected in standard applications, which may vary with specific uses. Users must conduct prior testing for their applications and make necessary adjustments.

Users are responsible for the safety of applications utilizing our products and must implement adequate safety measures to prevent physical injury, fire, or other risks in case of product failure. It is the user's duty to ensure that application designs comply with all applicable laws and standards. Our products must not be used in any applications where a product failure could reasonably result in personal injury, unless specifically authorized in a signed document by Zhuhai Hypersemi Co., Ltd.

No representations or warranties are made regarding the accuracy or completeness of this information, including any claims of non-infringement of third-party intellectual property rights. Zhuhai Hypersemi Co., Ltd. assumes no liability for any applications or uses of its products and does not grant any licenses to its intellectual property rights or those of others. We also make no claims regarding non-infringement of third-party intellectual property rights that may arise from applications.

Due to technical requirements, our products may contain hazardous substances. For details, please contact your nearest sales office. This document replaces all previous information and may be updated. We reserve the right to make changes.