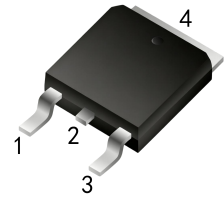
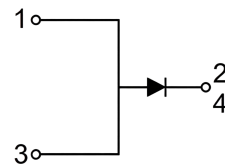


### Superfast Recovery Rectifiers

Parameter	Value	Unit
$V_{RRM}$	600	V
$I_{F(AV)}$	10	A



TO-252

#### Features

- Low profile package
- Fast Fast reverse recovery time
- Easy to pick and place
- Low forward Voltage drop

#### Applications

- Typical applications are in switching power supplies, converters, freewheeling diodes, and reverse battery protection.

#### Absolute Maximum Ratings (Ta=25°C, unless otherwise noted)

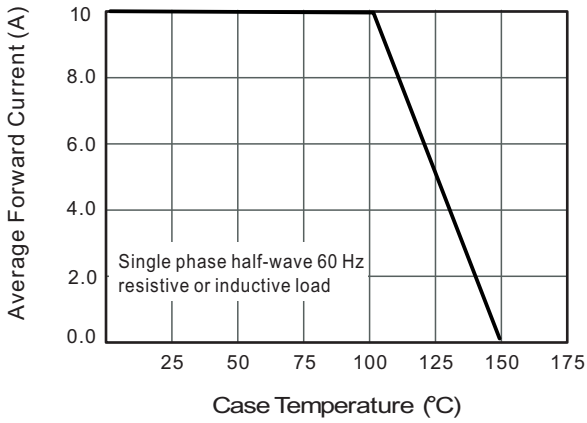
Parameter	Symbol	Value	Unit	
Maximum Recurrent Peak Reverse Voltage	$V_{RRM}$	600	V	
Maximum RMS Bridge Input Voltage	$V_{RMS}$	420	V	
Maximum DC Blocking Voltage	$V_{DC}$	600	V	
Maximum Average Forward Rectified Current	$I_{F(AV)}$	10	A	
Peak Forward Surge Current 8.3ms Single Half Sine-Wave Superimposed on Rated Load (JEDEC Method)	$I_{FSM}$	170	A	
Maximum Forward Voltage at 10A DC	$V_F$	1.50	V	
Maximum DC Reverse Current at Rated DC Blocking Voltage	$I_R$	$T_A=25^\circ\text{C}$	1.0	$\mu\text{A}$
		$T_A=125^\circ\text{C}$	100	$\mu\text{A}$
Maximum Reverse Recovery Time (Note1)	$T_{RR}$	35	ns	
Typical Thermal Resistance	$R_{\theta JA}$	50	$^\circ\text{C}/\text{W}$	
Operating Temperature Range	$T_J$	-55 to +150	$^\circ\text{C}$	
Storage Temperature Range	$T_{STG}$	-55 to +150	$^\circ\text{C}$	

Notes:

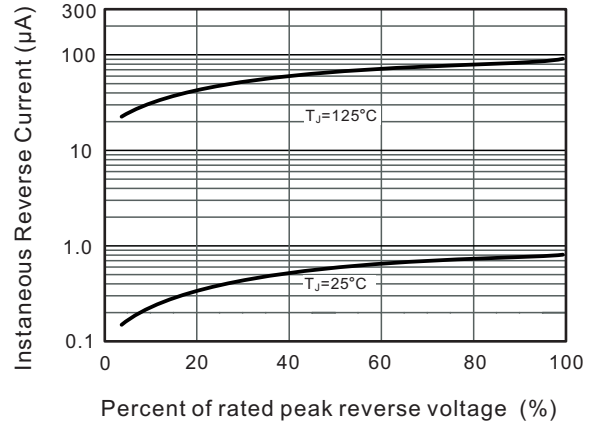
1. Measured with  $I_F=0.5\text{A}$ ,  $I_R=1\text{A}$ ,  $I_{rr}=0.25\text{A}$

**Typical Characteristics**

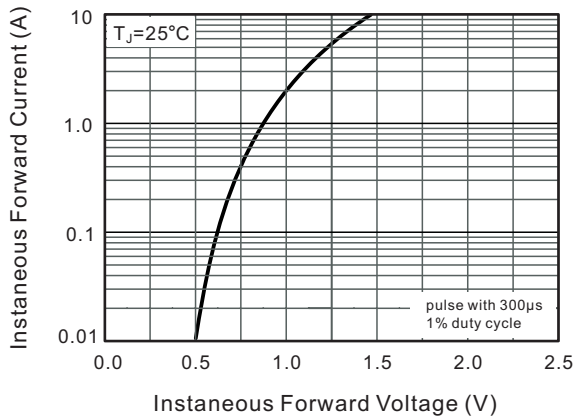
**Fig.1 Forward Current Derating Curve**



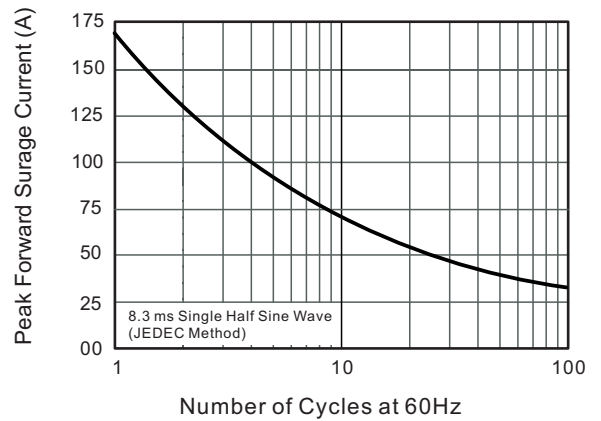
**Fig.2 Typical Reverse Characteristics**



**Fig.3 Typical Forward Characteristics**

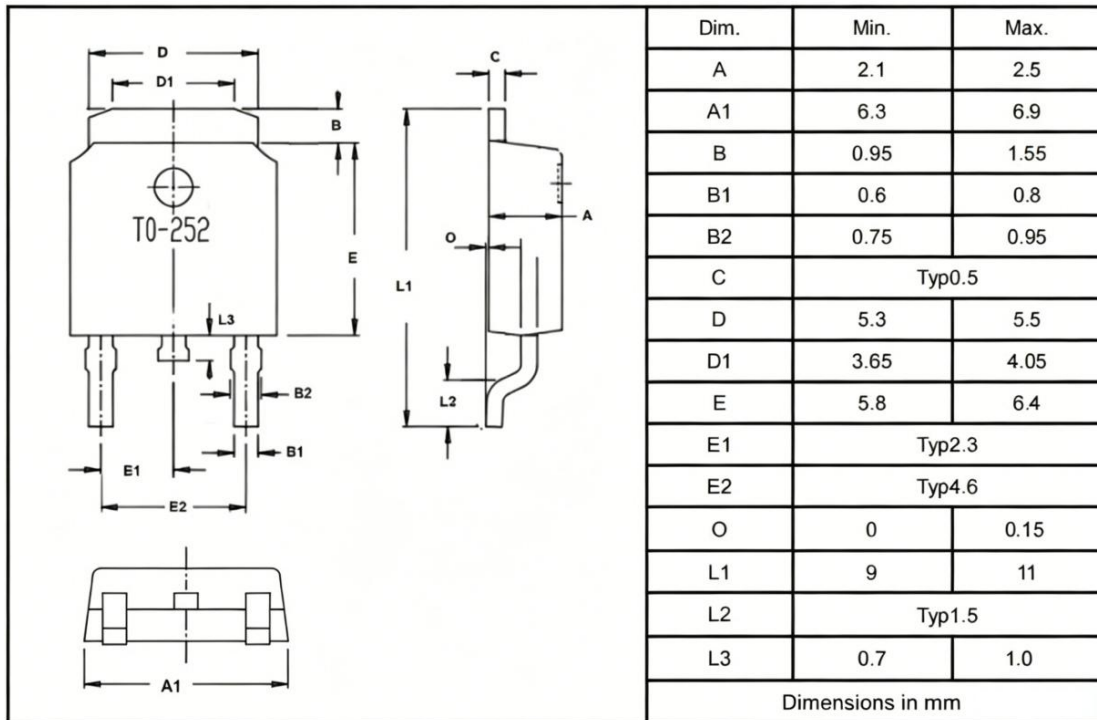


**Fig.4 Maximum Non-Repetitive Peak Forward Surge Current**



**Package Outlines**

**TO-252**



**\*Important Usage Information and Disclaimer**

The specifications of Zhuhai Hypersemi Co., Ltd. products are not guarantees of product characteristics. They reflect typical performance expected in standard applications, which may vary with specific uses. Users must conduct prior testing for their applications and make necessary adjustments.

Users are responsible for the safety of applications utilizing our products and must implement adequate safety measures to prevent physical injury, fire, or other risks in case of product failure. It is the user's duty to ensure that application designs comply with all applicable laws and standards. Our products must not be used in any applications where a product failure could reasonably result in personal injury, unless specifically authorized in a signed document by Zhuhai Hypersemi Co., Ltd.

No representations or warranties are made regarding the accuracy or completeness of this information, including any claims of non-infringement of third-party intellectual property rights. Zhuhai Hypersemi Co., Ltd. assumes no liability for any applications or uses of its products and does not grant any licenses to its intellectual property rights or those of others. We also make no claims regarding non-infringement of third-party intellectual property rights that may arise from applications.

Due to technical requirements, our products may contain hazardous substances. For details, please contact your nearest sales office. This document replaces all previous information and may be updated. We reserve the right to make changes.