

### Schottky Barrier Rectifiers

| Parameter   | Value    | Unit |
|-------------|----------|------|
| $V_{RRM}$   | 100      | V    |
| $I_{F(AV)}$ | 20(2*10) | A    |

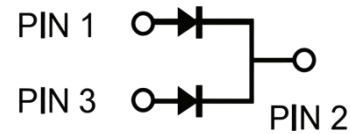

#### Features

- Common cathode structure
- Low power consumption, high efficiency
- Good high-temperature characteristics
- Over voltage protection loop, high reliability

#### Applications

- Power Factor Correction(PFC)
- Switched Mode Power Pully(SMPS)
- Uninterruptible Power Supply(UPS)
- Air Conditioner

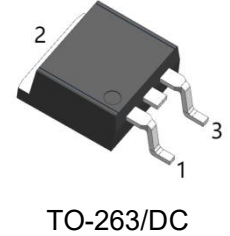
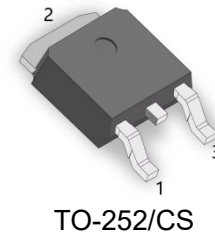
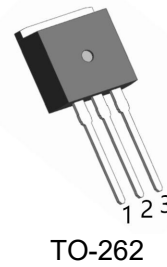

#### Absolute Maximum Ratings( $T_c=25^\circ\text{C}$ , unless otherwise noted)

| Parameter  | Symbol          | Value          | Unit             |
|--|-----------------|----------------|------------------|
| Maximum Repetitive Peak Reverse Voltage  | $V_{RRM}$       | 100            | V                |
| Working Peak Reverse Voltage   | $V_{RWM}$       | 100            | V                |
| Maximum DC Blocking Voltage  | $V_{DC}$        | 100            | V                |
| Maximum Average Forward Rectified Current  | $I_{F(AV)}$     | Per Leg        | 10               |
|  |                 | Total          | 20               |
| Peak Forward Surge Current, 8.3 ms Single Half Sine-wave Superimposed on Rated Load (JEDEC method) | $I_{FSM}$       | 180            | A                |
| Maximum Junction Temperature   | $T_J$           | 175            | $^\circ\text{C}$ |
| Storage Temperature Range  | $T_{STG}$       | -40 to +150    | $^\circ\text{C}$ |
| Typical Thermal Resistance   | $R_{\theta JC}$ | TO-262, TO-263 | 2.0              |
|  |                 | TO-220F        | 3.5              |
|  |                 | TO-252         | 2.5              |

Note1: Thermal resistance from Junction to case per leg mounted on heat sink.

### Electrical Characteristics unless otherwise specified

| Parameter            |                   | Symbol | Value |      | Unit    |
|----------------------|-------------------|--------|-------|------|---------|
| Forward Voltage Drop |                   |        | Typ.  | Max. |         |
| $I_F=100\mu A$       | $T_J=25^\circ C$  | $V_R$  | 120   | 135  | V       |
| $I_F=10A$            | $T_J=25^\circ C$  | $V_F$  | 0.81  | 0.85 |         |
|                      | $T_J=125^\circ C$ |        | 0.7   | 0.72 |         |
| $V_R=V_{RRM}$        | $T_J=25^\circ C$  | $I_R$  | 0.23  | 1.0  | $\mu A$ |
|                      | $T_J=125^\circ C$ |        | -     | 5.0  | mA      |

Note2:Pulse test: 300 $\mu s$  pulse width, 1% duty cycle

### Typical Characteristics

Fig 1.  $I_F$  VS  $V_F$

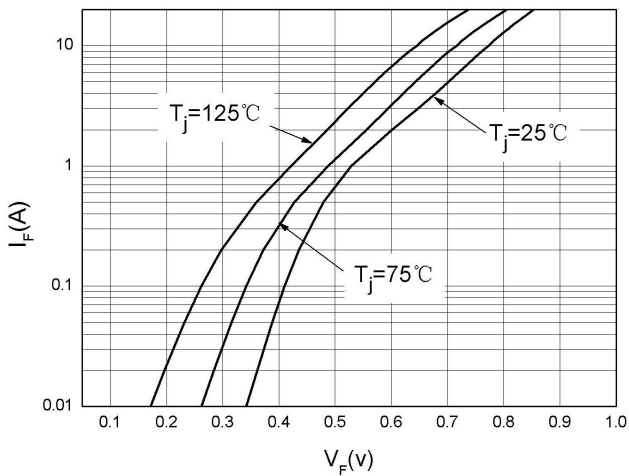

Fig 2.  $I_R$  VS  $V_R$

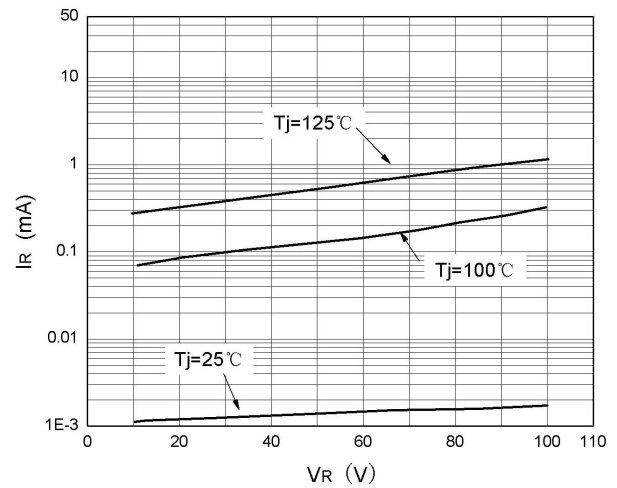

Fig 3.  $I_F(AV)$  vs  $T_C$

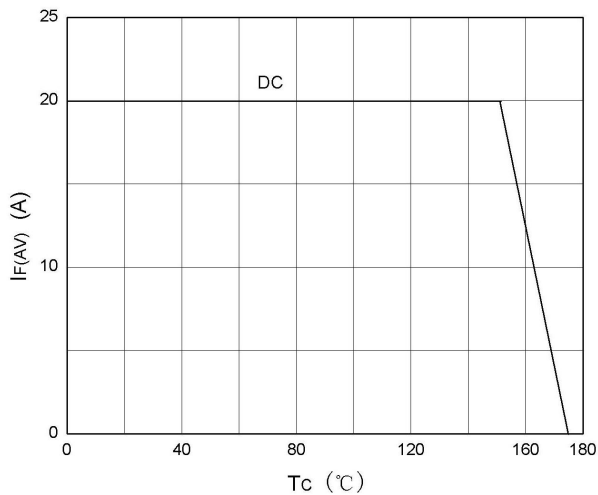
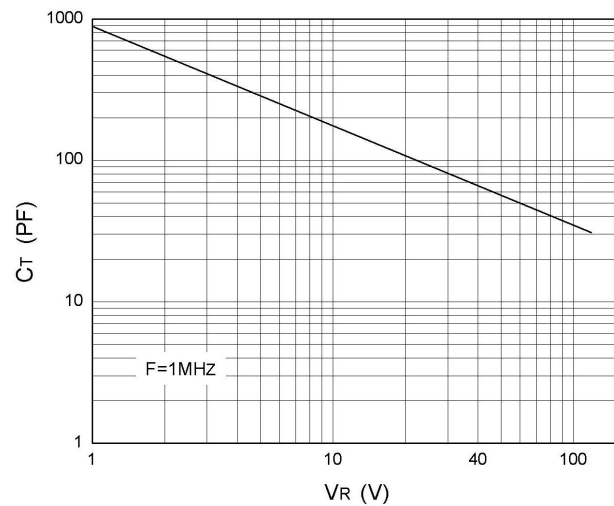
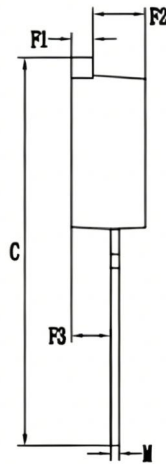
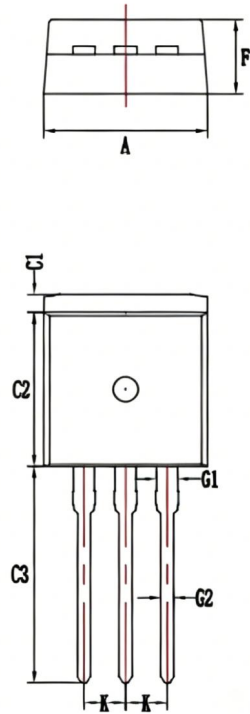

Fig 4.  $C_T$  vs  $V_R$



### Package Outlines

#### TO-262



| DIMENSIONS(unit:mm) |        |        |
|---------------------|--------|--------|
| Symbol              | Min    | Max    |
| A                   | 9.900  | 10.100 |
| C                   | 23.500 | 23.900 |
| C1                  | 1.100  | 1.200  |
| C2                  | 9.300  | 9.500  |
| C3                  | 13.000 | 13.300 |
| Ø                   | 3.600  | 3.900  |
| F                   | 4.400  | 4.600  |
| F1                  | 1.250  | 1.350  |
| F2                  | 3.100  | 3.300  |
| F3                  | 2.300  | 2.700  |
| G1                  | 1.220  | 1.320  |
| G2                  | 0.750  | 0.850  |
| K                   | 2.540  |        |
| M                   | 0.450  | 0.550  |

#### TO-220F

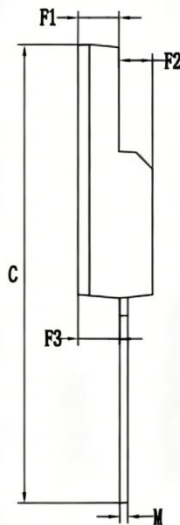
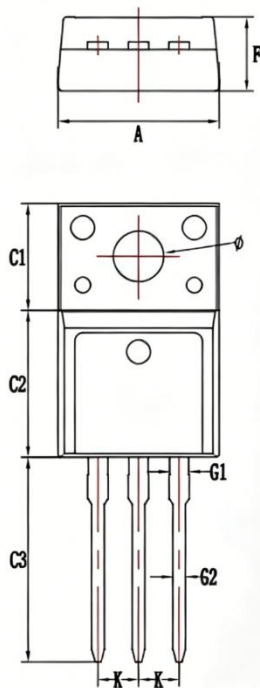

| DIMENSIONS(Unit:mm) |        |        |
|---------------------|--------|--------|
| Symbol              | Min    | Max    |
| A                   | 10.000 | 10.200 |
| C                   | 28.600 | 29.100 |
| C1                  | 6.580  | 6.780  |
| C2                  | 9.120  | 9.320  |
| C3                  | 12.800 | 13.100 |
| Ø                   | 3.330  | 3.430  |
| F                   | 4.450  | 4.750  |
| F1                  | 2.400  | 2.600  |
| F2                  | 2.000  | 2.200  |
| F3                  | 2.300  | 2.700  |
| G1                  | 1.150  | 1.250  |
| G2                  | 0.750  | 0.850  |
| K                   | 2.540  |        |
| M                   | 0.450  | 0.550  |

### TO-263

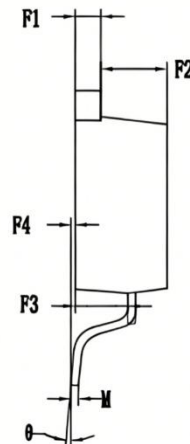
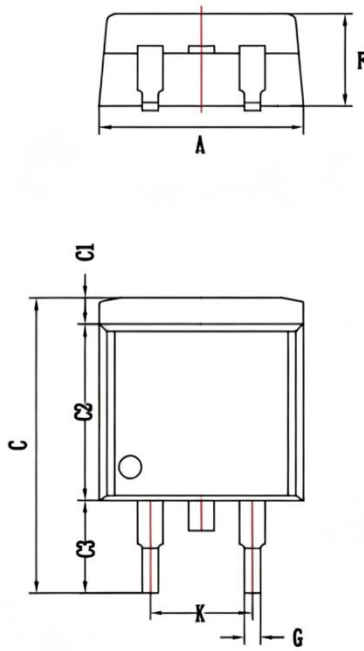

| DIMENSIONS(Unit:mm) |        |        |
|---------------------|--------|--------|
| Symbol              | Min    | Max    |
| A                   | 10.000 | 10.200 |
| C                   | 14.450 | 14.850 |
| C1                  | 1.250  | 1.350  |
| C2                  | 8.640  | 8.840  |
| C3                  | 4.460  | 4.760  |
| F                   | 4.420  | 4.720  |
| F1                  | 1.220  | 1.320  |
| F2                  | 3.200  | 3.400  |
| F3                  | 2.470  | 2.720  |
| F4                  | 0.000  | 0.200  |
| $\theta$            | 0°     | 8°     |
| G                   | 0.750  | 0.850  |
| K                   | 5.080  |        |
| M                   | 0.330  | 0.430  |

### TO-252

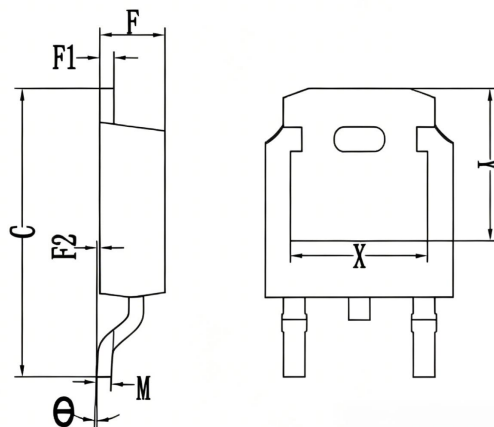
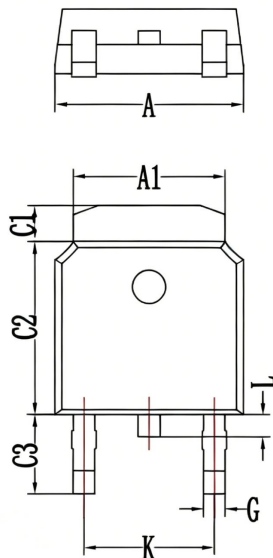

| DIMENSIONS(Unit:mm) |        |        |
|---------------------|--------|--------|
| Symbol              | Min    | Max    |
| A                   | 6.500  | 6.700  |
| A1                  | 5.230  | 5.430  |
| C                   | 10.000 | 10.400 |
| C1                  | 1.220  | 1.320  |
| C2                  | 6.000  | 6.200  |
| C3                  | 2.700  | 3.000  |
| F                   | 2.200  | 2.400  |
| F1                  | 0.450  | 0.550  |
| F2                  | 0.000  | 0.100  |
| M                   | 0.450  | 0.550  |
| K                   | 4.550  | 4.650  |
| G                   | 0.710  | 0.810  |
| L                   | 0.600  | 0.900  |
| $\theta$            | 0°     | 5°     |
| X                   | 4.650  | 4.850  |
| Y                   | 5.250  | 5.550  |

**\*Important Usage Information and Disclaimer**

The specifications of Zhuhai Hypersemi Co., Ltd. products are not guarantees of product characteristics. They reflect typical performance expected in standard applications, which may vary with specific uses. Users must conduct prior testing for their applications and make necessary adjustments.

Users are responsible for the safety of applications utilizing our products and must implement adequate safety measures to prevent physical injury, fire, or other risks in case of product failure. It is the user's duty to ensure that application designs comply with all applicable laws and standards. Our products must not be used in any applications where a product failure could reasonably result in personal injury, unless specifically authorized in a signed document by Zhuhai Hypersemi Co., Ltd.

No representations or warranties are made regarding the accuracy or completeness of this information, including any claims of non-infringement of third-party intellectual property rights. Zhuhai Hypersemi Co., Ltd. assumes no liability for any applications or uses of its products and does not grant any licenses to its intellectual property rights or those of others. We also make no claims regarding non-infringement of third-party intellectual property rights that may arise from applications.

Due to technical requirements, our products may contain hazardous substances. For details, please contact your nearest sales office. This document replaces all previous information and may be updated. We reserve the right to make changes.